



Series 132

XTS

C

2800rpm

ø 24mm

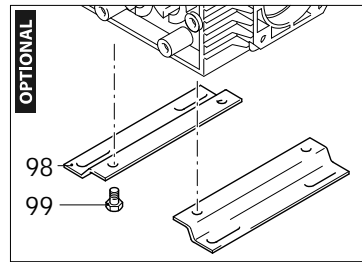
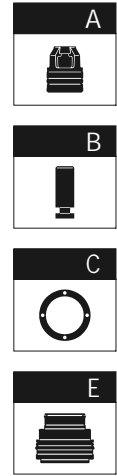
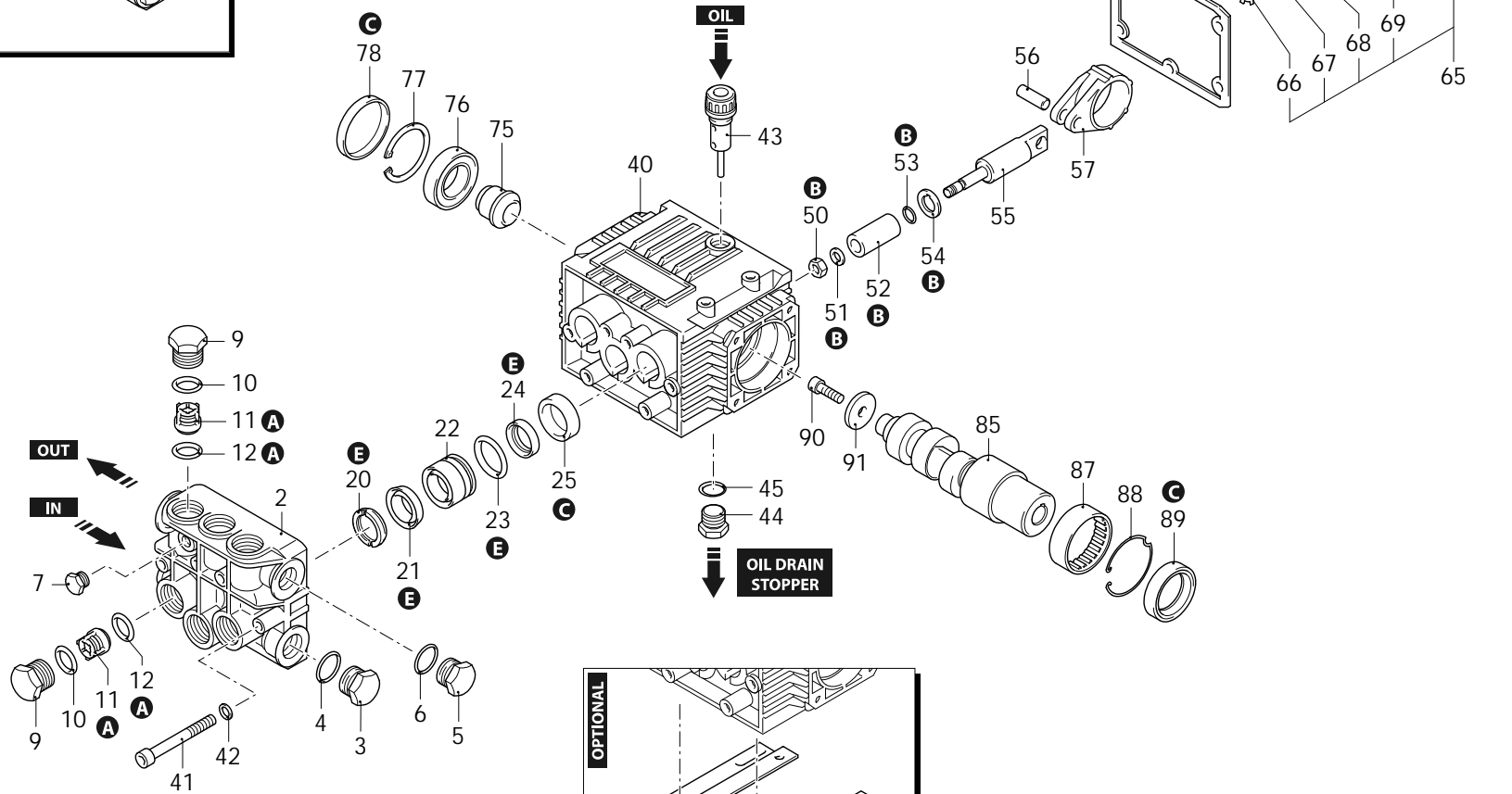
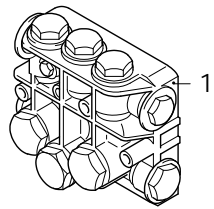
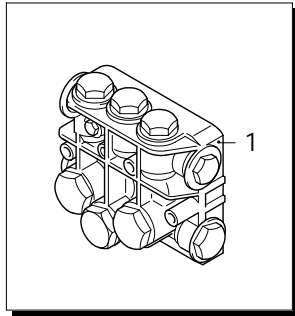

AR-1_000015_v01

29/11/2021



Series 132

XTS

C

2800rpm

ø 24mm

P	Code	Description	Q	Note	Validity	P	Code	Description	Q	Note	Validity
1	1269221	Head assembly	1	Ø 15		75	1320330	Bushing	1		
2	1320022	Head	1			76	1320370	Bearing	1		
3	820361	Plug	1	1/2" G brass	C=40Nm	77	1260790	Ring	1	seeger Ø1 52	
4	180101	O-ring	1	Ø 17,5x2	Lubricate with grease Molykote PG54	78	1266740	Cover	1		
5	1980740	Plug	1	3/8" G brass	C=20Nm	85	1321170	Shaft	1	4 marked	
6	740290	O-ring	1	Ø 14x1,78	Lubricate with grease Molykote PG54	87	1321190	Bearing	1		Assemble with tool [1780610]
7	620301	Plug	1	1/8" G	Screw with Loxeal 55-14	88	1321080	Ring	1		
9	1260162	Plug	6		C=34Nm	89	480671	Ring	1	seal	Assemble with tool [1781000]
10	960160	O-ring	6	Ø 17,86x2,62	Lubricate with grease Molykote PG54	90	390430	Screw	1	TE M6x25	C=24Nm
11	1269050	Complete valve	6			91	780230	Washer	1		
12	880830	O-ring	6	Ø 15,54x2,62		98	1263890	Foot	2		
20	1520120	Ring	3	support Ø 15		99	1260470	Screw	4	TE M8x10	C=24Nm
21	1271650	Water seal	3	Ø 15	Lubricate with grease Molykote PG54	A	1864	Valve kit	1		
22	1260151	Piston guide	3	Ø 15		B	2628	Piston kit	1	Ø 15	
23	1260420	O-ring	3	Ø 26,70x1,78	Lubricate with grease Molykote PG54	C	1860	Oil seal kit	1		
24	1260440	Water seal	3	Ø 15	Lubricate with grease Molykote PG54	E	1866	Water seal kit	1	Ø 15	
25	1260460	Oil seal	3			E	2029	Water seal kit	1	Ø 15 Viton	
40	1320010	Pump body	1								
41	680570	Screw	6	TCEI M6x60	C=10Nm						
42	1381550	Washer	6								
43	880130	Plug	1								
44	1980740	Plug	1	3/8" G brass	C=20Nm						
45	740290	O-ring	1	Ø 14x1,78	Lubricate with grease Molykote PG54						
46	1260040	Oil seal	1								
47	1260760	Screw	6	TCEI M5x20	C=5,4Nm						
50	1260110	Nut	3	M8	Screw with Loxeal 55-14 / C=12Nm						
51	1260100	Washer	3								
52	1260120	Piston	3	Ø 15							
53	480480	O-ring	3	Ø 4,48x1,78							
54	1260091	Plate	3								
55	1260070	Piston	3	guide							
56	1260080	Pin	3								
57	1320140	Connecting-rod	3	bronze							
65	1329010	Cover	1	complete							
66	1260430	Ring	1								
67	1780690	Plate	1								
68	1260250	Level gauge	1								
69	1140450	O-ring	1	Ø 20,24x2,62	Lubricate with grease Molykote PG54						

Revision: 1

Oil type: SAE 15W40

Attachment:

Date: 29/11/2021

Oil quantity: 0,280 Kg

C=Tightening torque (Tolerance +0 ÷ -10%)